

Article number: 0110090

Description: Retaining ring JS 85x4
Springsteel

Measures

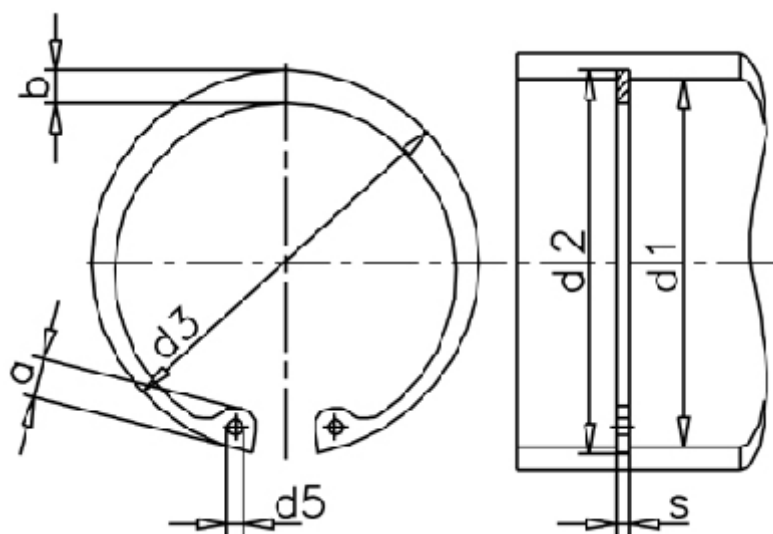

a max	= 9.7	Description	= JS 85	t	= 1.75
AN mm ²	= 477	FN kN	= 79.5	tol	= 0.35
B	= 1.78	FRg kN	= 55.0	tol	= +1,30 -0,54
b	= 7.2	FR kN	= 358.0	tol	= -0.10
d1	= 85	g	= 3.0	Tong	= ZGJ-4
d2	= 88.5	m min	= 4.15	Weight kg/1000	= 33.8
d3	= 90.5	Nominal drive	= 5.3		
d5 min	= 3.5	s	= 4.00		